



Since : 1993

J.C. GUPTA & SONS

Fastener Super Speciality

GSTIN : 29AABFJ2719C1ZO
IEC : 00710030274

#7/A, Sree Venkateshwara Building, Sadar Patrappe Road, Bengaluru - 560002



41478141, 9880539870



www.jcfasteners.com



sales@jcfasteners.com

DIN 463 Tab Washers With 2 Tabs - Long & Short Tab



Catalogue Datasheet **B6D08**

Stainless Steel A4/1.4401 (SS316)

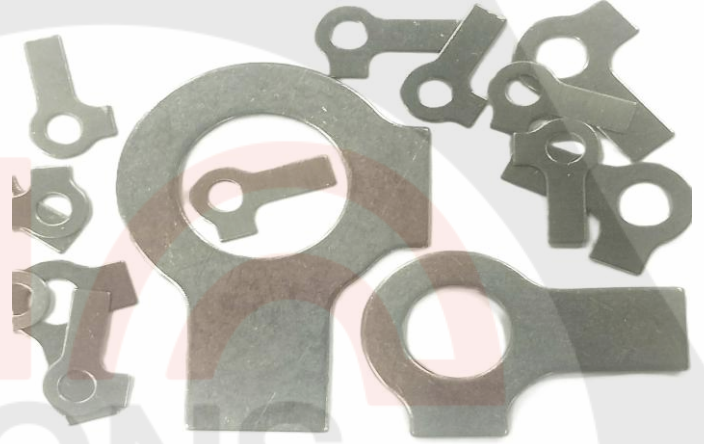
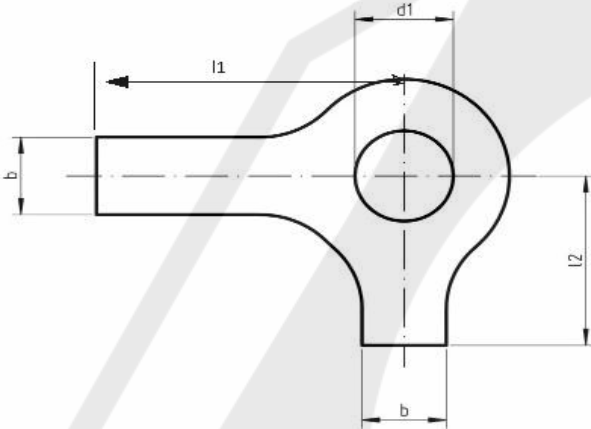

Quote the item code given below with your order/ inquiries:

Dimensions in mm

Bolt Size (Nominal Size) d1	Item Code	Outside Diameter d2	Tab Width b	Tab Length		Thickness s
				l1	l2	
M3 (3.2)	B6D0803000	7.00	4	13.00	5.00	0.38
M4 (4.3)	B6D0804000	9.00	5	14.00	6.50	0.38
M5 (5.3)	B6D0805000	10.00	6	16.00	8.00	0.50
M6 (6.4)	B6D0806000	12.50	7	18.00	9.00	0.50
M8 (8.4)	B6D0808000	17.00	8	20.00	11.00	0.75
M10 (10.5)	B6D0810000	21.00	10	22.00	13.00	0.75
M12 (13)	B6D0812000	24.00	12	28.00	15.00	1.00
M14 (15)	B6D0814000	28.00	12	28.00	16.00	1.00
M16(17)	B6D0816000	30.00	15	32.00	18.00	1.00
M18 (19)	B6D0818000	34.00	18	36.00	20.00	1.00
M20 (21)	B6D0820000	37.00	18	36.00	21.00	1.00
M22 (23)	B6D0822000	39.00	20	42.00	23.00	1.00
M24 (25)	B6D0824000	44.00	20	42.00	25.00	1.00
M27 (28)	B6D0827000	50.00	23	48.00	29.00	10.00
M30 (31)	B6D0830000	56.00	26	52.00	32.00	10.00

Sizes in BLUE are non-preferred. Availability is limited and MOQ higher.

Data is strictly informative

Note: All Austenitic Stainless Steel Fasteners may exhibit some magnetic properties due to the manufacturing process.

Refer: ISO 3506-2 Annex F