



Since : 1993

J.C. GUPTA & SONS

Fastener Super Speciality

GSTIN : 29AABFJ2719C1ZO
IEC : 00710030274

#7/A, Sree Venkateshwara Building, Sadar Patrapa Road, Bengaluru - 560002

41478141, 9880539870 www.jcfasteners.com sales@jcfasteners.com



Catalogue Datasheet **B6C41S**

Stainless Steel A4/1.4401 (SS316)

BLIND RIVET NUT OPEN

Round Shank Knurled Large Flange [LF]

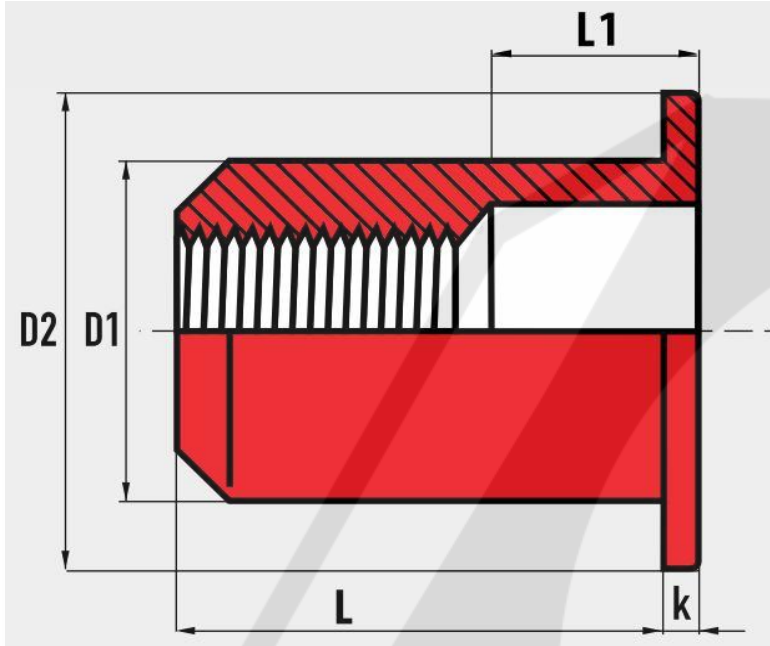

Dimensions in mm

Thread Size	Part No	Grip Range	Hole Size	D1 Body Dia	D2	L	k	Pull-In	Maximum Torque
Dia					Collar Dia	Body Length	Collar Thickness		
M3x0.5 1GR	B6C4103001S	0.5-2.0 mm	5.0 mm	4.9	7.0	10.0	0.9	4000 N	1.2 Nm
M4x0.7 1GR	B6C4104001S	0.5-3.0 mm	6.0 mm	5.9	9.0	10.0	1.0	6800N	3.0 Nm
M4x0.7 2GR	B6C4104002S	3.0-4.5 mm				11.5			
M5x0.8 1GR	B6C4105001S	0.5-3.0 mm	7.0 mm	6.9	10.0	12.0	1.0	10000 N	6.0 Nm
M5x0.8 2GR	B6C4105002S	3.0-4.5 mm				15.0			
M6x1.0 1GR	B6C4106001S	0.5-3.0 mm	9.0 mm	8.9	13.0	14.5	1.5	15000 N	10.0 Nm
M6x1.0 2GR	B6C4106002S	3.0-5.0 mm				16.0			
M8x1.25 1GR	B6C4108001S	0.5-3.0 mm	11.0 mm	10.9	16.0	16.0	1.5	27000 N	24.0 Nm
M8x1.25 2GR	B6C4108002S	3.0 -5.5 mm				18.5			
M10x1.5 1GR	B6C4110001S	0.5-3.0 mm	13.0 mm	12.9	19.0	17.0	2.0	37000 N	48.0 Nm
M10x1.5 2GR	B6C4110002S	3.0-6.0 mm				22.0			
M12x1.75 1GR	B6C4112001S	1.0-4.0 mm	16.0 mm	15.9	23.0	23.0	2.0	54000 N	82.0 Nm

Sizes in Blue are non preferred. Availability is limited and higher MOQ may apply.

Data is strictly informative

